



RT 335





RT 335

Notable Features

- **Boom-94 ft**
- **Jib- 32 ft or 49 ft (offsettable)**
- **Engine-Cummins 6BT5.9 152 hp**
- **Winch**
 - **fpm-533**
 - **Max Line Pull-15,639 lbs**
- **Pumps**
 - **Type-Gear Pumps (3)**
 - **Total GPM-119**
- **Tires-23.5xR25**



RT 300 SERIES

Rough Terrain Cranes



FEATURES

- **30-35 tons (27-32 mt)**
maximum lifting capacity
- **94 ft. (28.6 m)**
maximum boom length
- **147 ft. (44.8 m)**
maximum tip height
- Four-section full power, mechanically synchronized boom with single lever control
- Swingaway jib offsettable 0°, 15° or 30°
- Two-speed main and auxiliary winches
- Quick-reeving boom head and hook block
- Fully independent multi-position out and down outriggers
- Environmental operator's cab optimizes load visibility and productivity
- RCI 510 load system Rated Capacity Indicator
- Easy access for routine servicing of the engine, transmission, batteries, etc. provided by hinged lockable access doors.
- Easy to read load chart books include range diagrams
- 12-month or 2000 hours warranty, major weldments are 5-years or 10,000 hours

**Simple, Available
and Cost Effective™**

Machines shown may have optional equipment.

TEREX RT 300 SERIES

Rough Terrain Cranes

RT 330 – 30 tons (27 mt)

RT 335 – 35 tons (32 mt)

94 ft. (28.6 m)

FOUR-SECTION, FULL-POWER, MECHANICALLY SYNCHRONIZED BOOM WITH SINGLE LEVER CONTROL

- High strength, four plate construction welded inside and out with embossed side plate holes to reduce weight and increase strength.
- Single boom hoist cylinder provides boom elevation of -5° to 76° for easier reeving changes and close radius operation.
- Quick-reeving boom head; no need to remove wedge from socket.
- 360° house lock standard

ENVIRONMENTAL OPERATOR'S CAB

- Rated Capacity Indicator (RCI) system including anti-two block system with automatic function disconnects.
- Deluxe six-way adjustable operator's seat has torsion bar suspension and adjustable head and arm rests.
- Sound and weather insulated for comfort.
- Removable front window, hinged tinted glass skylight, and sliding right-hand window.
- Dash-mounted controls for swing, boom telescope, boom hoist, and single lever two-speed main winch; pedals for swing brake and boom hoist. Foot accelerator with hand throttle.
- Complete instrumentation. Environmentally-sealed rocker switches. Circuit breakers in cab.

RUGGED, EASY-TO-MANEUVER CARRIER

- Box-type chassis construction with reinforcing cross members.
- Full power-shift transmission with integral torque converter; neutral start; 6 speeds forward 3 reverse.
- Hydraulic four-wheel power steering for 2-wheel, 4-wheel or crab steer.
- Full air brakes with air dryer.
- Fully independent hydraulic outriggers may be utilized fully extended to 22 ft. (6.71 m), in their 1/2 extended position, or fully retracted.
- Tail swing only 9 ft. (2.74 m).
- Standard Cummins 6BT5.9 diesel engine.
- Easy access for routine servicing of the engine, transmission, batteries, etc. is provided by hinged lockable access doors without the need to unbolt access panels.
- Engine compartment access doors (4), and operators cab are all keyed alike.
- All outside compartments and fluid reservoir access doors/caps have lockable latches or are equipped with padlock hasps.
- Standard 23.5R25 tires.
- Tachometer and rear axle centering light standard.



POWERFUL, TWO-SPEED WINCHES

- 533 fpm (162.5 m/min) maximum line speed, 15,639 lbs. (7093 kg) maximum line pull. Single lever control.
- Integral automatic brake.
- Electronic drum indicators.
- Grooved drum, tapered flanges, and spring loaded cable roller for improved spooling.

HIGH CAPACITY, DEPENDABLE HYDRAULIC SYSTEM

- Three gear pumps driven off the transmission. Combined system capability is 119 gpm (450 lpm).
- Hydraulic reservoir with 114 gal. (432 l) capacity and full flow oil filtration system.

OPTIONS INCLUDE:

- 32 ft. or 32 to 49 ft. (9.75 or 9.75 to 14.93 m) swing-on jib. Both offset 0°, 15° or 30°.
- Auxiliary winch with rope.
- Heater/defroster, air conditioner.
- Cold weather starting aid.
- 21:00 x 25, 28 P.R. tires.
- CAT 3116 DITA diesel engine.

For more information, product demonstration, or details on purchase, lease and rental plans, please contact your local Terex Cranes Distributor.

We reserve the right to amend these specifications at any time without notice. The only warranty applicable is our standard written warranty applicable to the particular product and sale. We make no other warranty, expressed or implied.



TEREX

Waverly Operations
106 12th Street S.E.
Waverly, IA 50677-9466 USA
TEL: (319) 352-3920
FAX: (319) 352-5727
E-MAIL: inquire@terexwaverly.com
WEB: <http://www.terex-cranes.com>



RT 300 SERIES

rough terrain cranes
specifications

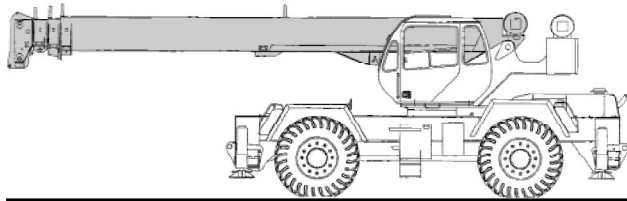

STANDARD BOOM EQUIPMENT

BOOM

30-94 ft. (9.23-28.78 m), four section full power, mechanically synchronized boom. High-strength four plate construction with side plate holes. Anti-friction slide pads. Single boom hoist cylinder. Maximum tip height is 100 ft. (30.48 m).

BOOM HEAD

Welded to fourth section of boom. Four or five load sheaves and two idler sheaves mounted on heavy duty, anti-friction bearings. Quick reeving boom head. Provisions made for side-stow jib mounting.

OPTIONAL BOOM EQUIPMENT

JIBS

32 ft. (9.68 m) side stow swing-on one-piece lattice type jib. Single sheave mounted on anti-friction bearing. Jib is offsettable at 0°, 15°, or 30°. Maximum tip height is 129 ft. (39.32 m) with 94 ft. (28.49 m) boom.

32-49 ft. (9.68 -14.86 m) side-stow swing-on lattice type jib. Single sheave mounted on anti-friction bearing. Jib is extendible to 49 ft. (14.86 m) by means of a 17 ft. (5.18m) manual pull-out tip section, roller supported for ease of extension. Jib is offsettable at 0°, 15°, or 30°. Maximum tip height is 147 ft. (44.81 m) with 94 ft. (28.49 m) boom.

AUXILIARY BOOM HEAD

Removable auxiliary boom head has single sheave mounted on anti-friction bearing. Removable pin-type rope guard for quick reeving. Installs on main boom peak only. Removal is not required for jib use.

HOOK BLOCK

Three or four metallic sheaves on anti-friction bearings with hook and heavy duty hook latch.

HOOK & BALL

7.0 ton (6.3 mt) top swivel ball with hook and hook latch.

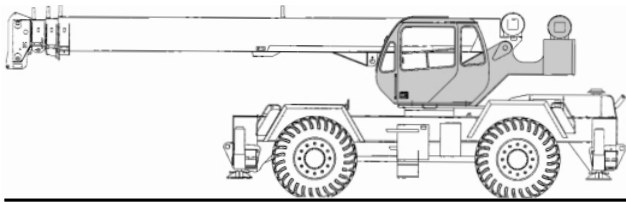

STANDARD UPPERSTRUCTURE EQUIPMENT

UPPERSTRUCTURE FRAME

All welded one-piece structure fabricated with high tensile strength alloy steel. Counterweight is removable.

TURNTABLE CONNECTION

Swing bearing is a single row, ball type, with external teeth. The swing bearing is bolted to both the revolving upperstructure and the carrier.

SWING

A hydraulic motor drives a double planetary reduction gear for precise and smooth swing function. Swing speed (no load) is 2.8 rpm.

SWING BRAKE

Heavy duty multiple disc swing brake is mechanically actuated from operator's cab by foot pedal. Brake may be locked on or used as a momentary brake.

RATED CAPACITY INDICATOR

Rated Capacity Indicator with visual and audible warning system and automatic function disconnects. Second generation pictographic display includes: boom radius, boom angle, boom length, allowable load, actual load, and percentage of allowable load registered by bar graph. Operator settable alarms provided for swing angle, boom length, boom angle, tip height, and work area exclusion zone. Anti-two block system includes audio/visual warning and automatic function disconnects.

OPERATOR'S CAB

Environmental cab with all steel construction, optimized visibility, tinted safety glass throughout, and rubber floor matting is mounted on vibration absorbing pads. The cab has a sliding door on the left side, framed sliding window on the right side, hinged tinted all glass skylight and removable front

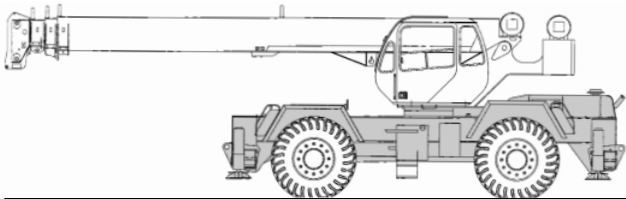

STANDARD CARRIER EQUIPMENT

CARRIER CHASSIS

High strength chassis with four-wheel drive and four-wheel steer (4x4x4). Has box beam type construction with reinforcing cross members, a precision machined turn table mounting plate and integrally welded outrigger boxes. Decking has anti-skid surfaces, including tool storage compartment, and access steps and handles left and right side and front and rear corners.

AXLES AND SUSPENSION

Rear axle is a planetary drive/steer type with automatic oscillation lockouts that engage when the superstructure is swung 10° in either direction. Front axle is a planetary drive/steer type, rigid mounted to the frame for increased stability.

windshield to provide optimized visibility of the load open or closed. Acoustical foam padding insulates against sound and weather. The deluxe six-way adjustable operator's seat is equipped with a torsion bar suspension and includes head and arm rests.

CONTROLS

All control levers and pedals are positioned for efficient operation. Hand operated control levers include swing, boom telescope, boom hoist, winch(s), shift, vernier adjustable hand throttle, and 360° house lock. Switches include ignition, engine stop, steering mode, parking brake, two speed winch, and outrigger controls. Foot control pedals include swing brake, boom raise, boom lower, service brakes and accelerator.

INSTRUMENTATION AND ACCESSORIES

In-cab gauges include air pressure, bubble level, engine oil pressure, fuel, engine coolant temperature, voltmeter, transmission temperature, transmission charge pump pressure. Indicators include low air, high coolant temperature/low engine oil pressure/high transmission temperature audio/visual warning, low coolant audio/visual warning, hoist drum rotation indicator, Rated Capacity Indicator and rear axle centered. Accessories include fire extinguisher; light package including headlights, tail light, brake lights, directional signals, four-way hazard flashers, dome & dash lights, and back-up lights with audible back-up alarm; windshield washer/wiper; skylight wiper; R.H. and L.H. rear view mirrors; and seat belt.

HYDRAULIC CONTROL VALVES

Valves are mounted in the rear of the upperstructure and are easily accessible. Valves are mechanically operated and include one three spool valve for boom elevation, telescope, and main winch; and one single spool valve for swing. High pressure regeneration feature provides 2-speed boom extension. Quick disconnects are provided for quick connection of pressure check gauges.

OPTIONAL EQUIPMENT

Auxiliary Winch • Heater/Defroster • Air Conditioner • Work Lights • Revolving Amber Light • Independent Rear Wheel Steering • Roof Mounted Spotlight

STEERING

Hydraulic four-wheel power steering for two-wheel, four-wheel, or crab steer is easily controlled by steering wheel.

Turning radius to center of outside tire.

	23.5R25 tires	21.00x25 tires
Two-wheel:	36' 10.75" (11.25 m)	36' 8.7" (11.19 m)
Four-wheel:	20' 4.7" (6.22 m)	20' 2.6" (6.16 m)

TRANSMISSION

Full power-shift transmission with integral torque converter has neutral safety start, 6 speeds forward, and 3 speeds reverse. Automatic pulsating back-up alarm.

STANDARD CARRIER EQUIPMENT (continued)

MULTI-POSITION OUT & DOWN OUTRIGGERS

Fully independent hydraulic outriggers may be utilized fully extended to 22 ft. (6.71 m), in their 1/2 extended position, or fully retracted. Easily removable floats, each with an area of 254 in² (1639 cm²), stow on the carrier frame. Complete controls and sight leveling bubble are located in the operator's cab.

WHEELS & TIRES

Disc type wheels with full tapered bead seat rim. 150.50 in (3.82 m) wheelbase.

TIRES

23.5R25** std.
21.00x25 28 PR opt.

SERVICE BRAKES

Cam operated air brakes on all four wheels; 20 1/4" x 4" (51.43x10.2 cm) drum brakes.

PARKING BRAKE

Front and rear axles equipped with spring-set, air released emergency/parking chambers.

OPTIONAL EQUIPMENT

Cold Weather Starting Aid • Immersion Heater • 24" (0.61m) Aluminum Outrigger Floats • Pintle Hook • Clearance Lights • Front Mounted Winch – 20,000 lbs (9072 kg)

HYDRAULIC SYSTEM

HYDRAULIC PUMPS

Three gear type pumps, one single and two in tandem, driven off the transmission. Combined system capability is 119 gpm (450 lpm). Includes pump disconnect.

Main and Auxiliary Winch Pump

59.5 gpm (225.2 lpm) @ 3,500 psi (246.1 kg/cm²)

Boom Hoist, Telescope Pump

38.5 gpm (145.7 lpm) @ 3,500 psi (246.1 kg/cm²)

Power Steering, Outrigger and Swing Pump

21 gpm (79.5 lpm) @ 2,500 psi (175 kg/cm²)

FILTRATION

Full flow oil filtration system with bypass protection includes a removable 60 mesh (250 micron) suction screen-type filter and 5 micron replaceable return line filter.

HYDRAULIC RESERVOIR

All steel, welded construction with internal baffles and diffuser. Provides easy access to filters and is equipped with an external sight level gauge. The hydraulic tank is pressurized to aid in keeping out contaminants and in reducing potential pump cavitation. Capacity is 114 gal (432 liters). Hydraulic oil cooler is standard.

MAIN WINCH SPECIFICATION

Hydraulic winch with bent axis piston motor and planetary reduction gearing provides 2-speed operation with equal speeds for power up and down. Winch is equipped with an integral automatic brake, grooved drum, tapered flanges, standard cable roller on drum, and electronic rotation indicator.

PERFORMANCE	LO-RANGE	HI-RANGE
Max. line speed (no load)		
First layer	184 fpm (56.1 m/min)	369 fpm (112.5 m/min)
Fifth layer	266 fpm (81.1 m/min)	533 fpm (162.5 m/min)
Max. line pull-first layer	15,639 lbs (7094 kg)	7,298 lbs (3310 kg)
Max. line pull-fifth layer	10,827 lbs (4911 kg)	5,052 lbs (2292 kg)
Permissible line pull	9,000 lbs (4082 kg)	

DRUM DIMENSIONS	DRUM CAPACITY
10.62 in (270 mm) drum diameter	Max. Storage: 570 ft (173.7 m)
17.55 in (446 mm) length	6th layer not a working layer
18.0 in (457 mm) flange dia.	Max. Useable: 455 ft (138.7 m)*
Cable: 5/8 in. x 450 ft (16 mm x 137.2 m)	
Cable type: 5/8 in. (16mm) 6x19 IWRC	* Based on min. flange height above
XIPS right regular lay, preformed	top layer to comply with ANSI B30.5

OPTIONAL AUX. WINCH

Hydraulic 2-speed winch with bent axis piston motor, power up and down, equal speed, planetary reduction with integral automatic brake, grooved drum with tapered flanges, drum roller, and rotation indicator.

PERFORMANCE

(Same as main winch)

DRUM DIMENSIONS AND CAPACITY

(Same as main winch)

OPTIONAL HOIST LINE – MAIN WINCH AND OPTIONAL AUXILIARY WINCH –

5/8 in. (16mm) rotation resistant compacted strand 18 x 19 or 19 x 19.

Min. breaking strength 22.6 tons (20.6 mt).

ENGINE SPECIFICATIONS

Make and Model	Cummins 6BT5.9 (Std.)	Caterpillar 3116 DITA (Opt.)
Type	6 cylinder	6 cylinder
Bore and Stroke	4.02 x 4.72 in (102x120 mm)	4.12 x 5.0 in (105x127mm)
Displacement	359 cu in (5.9 l)	402 cu in (6.6 l)
Gross Horsepower	152 @ 2,500 rpm	175 @ 2,400 rpm
Gross Torque	414 lb•ft(561 N•m) @ 1600 rpm	490 lb•ft(664 N•m) @ 1450 rpm
Aspiration	turbocharged	turbocharged & aftercooled
Air Filter	dry type	dry type
Electrical System	12 volt	12 volt
Alternator	102 amp	115 amp
Battery	(2) 12V-1600 CCA	(2) 12V-1600 CCA
Fuel Capacity	50 gal (189 l)	50 gal (189 l)

PERFORMANCE (Standard Engine)

Transmission Gear	Forward Drive	Maximum Speed	Maximum Tractive Effort	Gradeability @ Stall*
1	4-wheel	2.3 mph 3.7 km/h	56,357 lbs 25 564 kg	273.7%
2	4-wheel	4.1 mph 6.6 km/h	31,890 lbs 14 465 kg	59.5%
3	4-wheel	5.4 mph 8.7 km/h	24,261 lbs 11 005 kg	41.6%
4	2-wheel	9.6 mph 15.4 km/h	13,746 lbs 6235 kg	21.4%
5	2-wheel	13.6 mph 21.9 km/h	9,691 lbs 4396 kg	14.3%
6	2-wheel	24.0 mph 38.6 km/h	5,498 lbs 2494 kg	7.2%

*Based on a gross vehicle weight of 60,000 lbs. (27 216 kg).

GENERAL DIMENSIONS

NOTES:

- Dimensions given assume the boom is fully retracted in travel position and 23.5R25 tires. Add 3.0" (76 mm) for 21.00x25 tires.
- Minimum ground clearance under:
 - transmission - 21.62" (549 mm)
 - axle bowls - 18.65" (474 mm)

3. Approach and departure angles:
- | | | |
|-----------------------|---------|----------|
| | 23.5R25 | 21.00x25 |
| Approach angle (A) - | 22° | 26° |
| Departure angle (B) - | 18° | 21° |

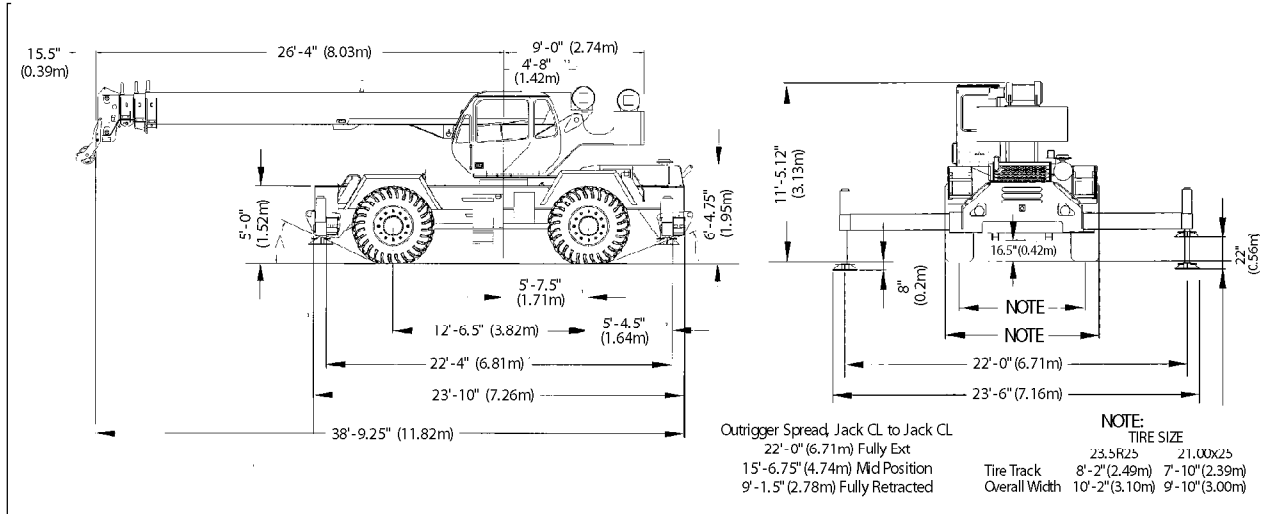

WEIGHTS & AXLE LOADS	GROSS WEIGHT LBS.	UPPER FACING FRONT		GROSS WEIGHT KG.	UPPER FACING FRONT	
		FRONT	REAR		FRONT	REAR
Basic Crane with 10,000 lb. (4536 kg) Counterweight	63,260	30,388	32,872	28 694	13 784	14 910
Add Options:						
32' (9.68 m) Swing-on jib (Stowed)	+ 1,368	+ 1,814	- 446	+ 621	+ 823	- 202
32'-49' (9.68 - 14.86 m) Swing-on Jib (Stowed)	+ 1,789	+ 2,147	- 358	+ 811	+ 974	- 163
Auxiliary Boom Head	+ 100	+ 260	- 160	+ 45	+ 118	- 73
Auxiliary Winch Controls and Plumbing Only	+ 75	+ 0	+ 75	+ 34	+ 0	+ 34
Auxiliary Winch with Wire Rope, Controls, Etc.	+ 264	- 56	+ 320	+ 120	- 25	+ 145
40T (36.3 mt) 4-Sheave Hook Block	+ 690	+ 1,017	- 327	+ 313	+ 461	- 148
30T (27.2 mt) 3-Sheave Hook Block	+ 670	+ 987	- 317	+ 304	+ 448	- 144
25T (22.7 mt) 2-Sheave Hook Block	+ 682	+ 1,005	- 323	+ 309	+ 456	- 147
6.25T Hook and Ball (In tool box)	+ 240	+ 261	- 21	+ 109	+ 118	- 9
Pintle Hook: Front	+ 45	+ 64	- 19	+ 20	+ 29	- 9
Rear	+ 45	- 22	+ 67	+ 20	- 10	+ 30
Substitute:						
450' (137.2 m) of 18x19 class spin resistant wire rope	+ 60	- 39	+ 99	+ 27	+ 18	+ 45

NOTE: Weights are for factory supplied equipment and are subject to 2% variation due to manufacturing tolerances. WE RESERVE THE RIGHT TO AMEND THESE SPECIFICATIONS AT ANY TIME WITHOUT NOTICE. THE ONLY WARRANTY APPLICABLE IS OUR STANDARD WRITTEN WARRANTY APPLICABLE TO THE PARTICULAR PRODUCT AND SALE. WE MAKE NO OTHER WARRANTY, EXPRESSED OR IMPLIED.



TEREX

Waverly Operations
 106 12th Street S.E.
 Waverly, IA 50677-9466 USA
 TEL: (319) 352-3920
 FAX: (319) 352-5727
 E-MAIL: inquire@terexwaverly.com
 WEB: http://www.terex-cranes.com

RT 335

rough terrain crane
35 ton capacity

range diagram & lifting capacities

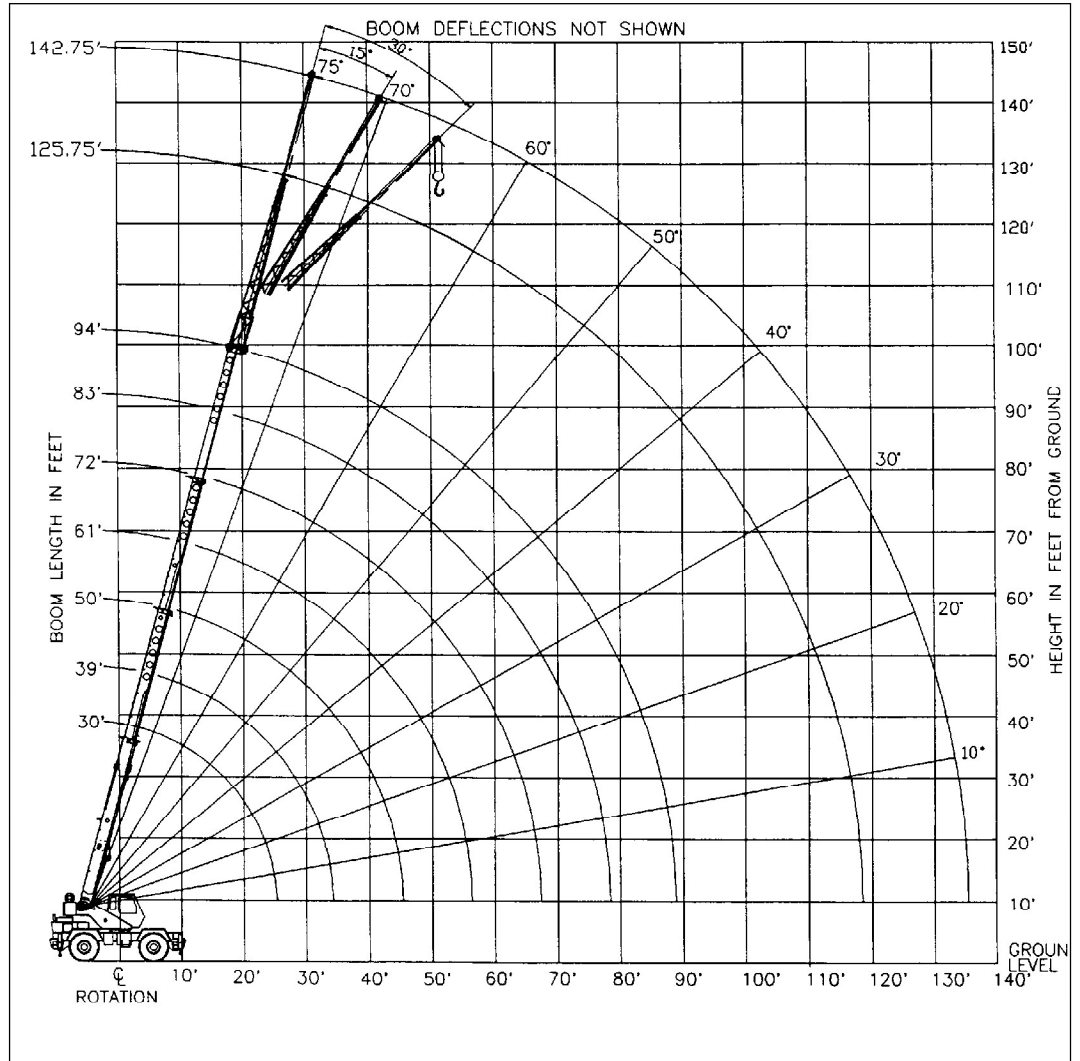
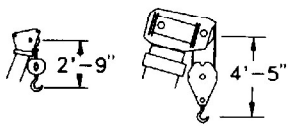

CRANE WORKING CONDITIONS

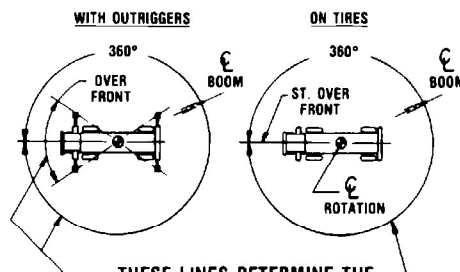

THESE LINES DETERMINE THE LIMITS OF WORKING POSITIONS WHICH CORRESPOND TO THOSE SHOWN ON THE CRANE CAPACITY CHART.

REDUCTION IN MAIN BOOM CAPACITY

All Jibs in Stowed Position _____ 0 Lbs.
Aux. Boom in Head Sheave _____ 100 Lbs.

HOOK BLOCK WEIGHTS

Hook & Ball _____ 239 Lbs.
Hook Block (3 Sheave) _____ 670 Lbs.
Hook Block (4 Sheave) _____ 690 Lbs.

Lifting Capacities – Pounds (30’ – 94’ boom)

MODEL RT 335

COUNTERWEIGHT:
W/AUX. WINCH 8900 LBS.
W/O AUX. WINCH 10,000 LBS.
BOOM LENGTH 30-94 FT.
OUTRIGGER SPREAD 22 FT.

STABILITY PERCENTAGE
ON OUTRIGGERS 85%
ON TIRES 75%
PCSA CLASS 10-156

CAUTION: Do not use this specification sheet as a load rating chart. The format of data is not consistent with the machine chart and may be subject to change.

ON OUTRIGGERS – FULLY EXTENDED

LOAD RADIUS (FT)	BOOM LENGTH 30 FT			BOOM LENGTH 39 FT			BOOM LENGTH 50 FT			LOAD RADIUS (FT)
	LOADED BOOM ANGLE (DEG)	OVER FRONT (LB)	360° (LB)	LOADED BOOM ANGLE (DEG)	OVER FRONT (LB)	360° (LB)	LOADED BOOM ANGLE (DEG)	OVER FRONT (LB)	360° (LB)	
10	63.0	70,000*	70,000*	69.4	46,600*	46,600*				10
12	58.5	60,800*	60,800*	66.2	46,600*	46,600*	71.7	46,600*	46,600*	12
15	51.4	50,600*	50,600*	61.2	46,600*	46,600*	68.0	44,300*	44,300*	15
20	37.4	36,100*	36,100*	52.3	36,900*	36,900*	61.6	37,500*	37,500*	20
25	13.7	27,300*	27,300*	42.0	28,200*	28,200*	54.8	28,800*	28,800*	25
30	**			28.8	22,300*	22,300*	47.3	22,900*	22,900*	30
35				**			38.7	18,800*	18,800*	35
40							27.9	15,600*	15,600*	40
45							7.9	13,100*	13,100*	45
50							**			50
55										55
60										60
65										65
70										70
75										75
80										80
85										85
90										90

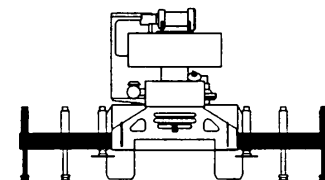

USE THESE CHARTS ONLY WHEN ALL OUTRIGGERS ARE FULLY EXTENDED

LOAD RADIUS (FT)	BOOM LENGTH 61 FT			BOOM LENGTH 72 FT			BOOM LENGTH 83 FT			BOOM LENGTH 94 FT			LOAD RADIUS (FT)
	LOADED BOOM ANGLE (DEG)	OVER FRONT (LB)	360° (LB)	LOADED BOOM ANGLE (DEG)	OVER FRONT (LB)	360° (LB)	LOADED BOOM ANGLE (DEG)	OVER FRONT (LB)	360° (LB)	LOADED BOOM ANGLE (DEG)	OVER FRONT (LB)	360° (LB)	
10													10
12													12
15	72.1	38,100*	38,100*										15
20	67.1	33,000*	33,000*	70.8	27,400*	27,400*							20
25	61.9	27,900*	27,900*	66.5	23,100*	23,100*	69.8	21,800*	21,800*	72.2	17,500*	17,500*	25
30	56.3	23,300*	23,300*	62.0	19,900*	19,900*	66.0	18,300*	18,300*	69.0	15,000*	15,000*	30
35	50.4	19,100*	19,100*	57.4	17,400*	17,400*	62.2	15,900*	15,900*	65.7	13,100*	13,100*	35
40	43.9	16,000*	16,000*	52.5	15,400*	15,400*	58.1	13,800*	13,800*	62.2	11,500*	11,500*	40
45	36.5	13,500*	13,500*	47.2	13,800*	13,800*	53.9	12,100*	12,100*	58.7	10,100*	10,100*	45
50	27.3	11,500*	11,500*	41.4	11,800*	11,800*	49.5	10,900*	10,900*	55.1	9,000*	9,000*	50
55	13.0	9,900*	9,900*	34.8	10,200*	10,200*	44.7	9,700*	9,700*	51.2	8,200*	8,200*	55
60	**			26.9	8,800*	8,800*	39.5	8,800*	8,800*	47.2	7,300*	7,300*	60
65				15.5	7,700*	7,700*	33.6	7,900*	7,800*	42.8	6,600*	6,600*	65
70				**			26.6	6,900*	6,800*	38.0	6,000*	6,000*	70
75							17.0	5,900*	5,800*	32.7	5,500*	5,500*	75
80							**			26.4	5,000*	5,000*	80
85										18.1	4,600*	4,500*	85
90										**			90

** MAXIMUM CAPACITY AT 0 DEGREE BOOM ANGLE

BOOM LENGTH 30 FT			BOOM LENGTH 39 FT			BOOM LENGTH 50 FT			BOOM LENGTH 61 FT			BOOM LENGTH 72 FT			BOOM LENGTH 83 FT			BOOM LENGTH 94 FT		
LOAD RADIUS (FT)	OVER FRONT (LB)	360° (LB)	LOAD RADIUS (FT)	OVER FRONT (LB)	360° (LB)	LOAD RADIUS (FT)	OVER FRONT (LB)	360° (LB)	LOAD RADIUS (FT)	OVER FRONT (LB)	360° (LB)	LOAD RADIUS (FT)	OVER FRONT (LB)	360° (LB)	LOAD RADIUS (FT)	OVER FRONT (LB)	360° (LB)	LOAD RADIUS (FT)	OVER FRONT (LB)	360° (LB)
25.6	26,300*	26,300*	34.3	18,500*	18,500*	45.3	12,900*	12,900*	56.3	9,500*	9,500*	67.3	7,200*	7,100	78.3	5,300	5,200	89.3	4,000	3,900

Lifting Capacities – Pounds (30’ – 94’ boom)

MODEL RT 335

COUNTERWEIGHT:
W/AUX. WINCH 8900 LBS.
W/O AUX. WINCH 10,000 LBS.
BOOM LENGTH 30-94 FT.
OUTRIGGER SPREAD 22 FT.

STABILITY PERCENTAGE
ON OUTRIGGERS 85%
ON TIRES 75%
PCSA CLASS 10-156

CAUTION: Do not use this specification sheet as a load rating chart. The format of data is not consistent with the machine chart and may be subject to change.

ON OUTRIGGERS – MID POSITION

LOAD RADIUS (FT)	BOOM LENGTH 30 FT		BOOM LENGTH 39 FT		BOOM LENGTH 50 FT		LOAD RADIUS (FT)
	LOADED BOOM ANGLE (DEG)	360° (LB)	LOADED BOOM ANGLE (DEG)	360° (LB)	LOADED BOOM ANGLE (DEG)	360° (LB)	
10	63.0	70,000*	69.4	46,600*			10
12	58.5	60,800*	66.2	46,600*	71.7	46,600*	12
15	51.4	50,600*	61.2	46,600*	68.0	44,300*	15
20	37.4	33,000	52.3	33,800	61.6	34,300	20
25	13.7	21,200	42.0	22,400	54.8	22,800	25
30	**		28.8	15,900	47.3	16,500	30
35			**		38.7	12,500	35
40					27.9	9,600	40
45					7.9	7,400	45
50					**		50
55							55
60							60
65							65
70							70
75							75
80							80
85							85
90							90

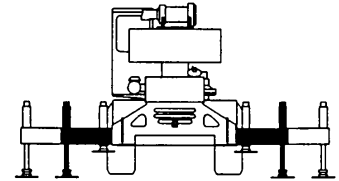

USE THESE CHARTS ONLY WHEN ALL OUTRIGGERS ARE PINNED IN MID POSITION

LOAD RADIUS (FT)	BOOM LENGTH 61 FT		BOOM LENGTH 72 FT		BOOM LENGTH 83 FT		BOOM LENGTH 94 FT		LOAD RADIUS (FT)
	LOADED BOOM ANGLE (DEG)	360° (LB)	LOADED BOOM ANGLE (DEG)	360° (LB)	LOADED BOOM ANGLE (DEG)	360° (LB)	LOADED BOOM ANGLE (DEG)	360° (LB)	
10									10
12									12
15	72.1	38,100*							15
20	67.1	33,000*	70.8	27,400*					20
25	61.9	23,100	66.5	23,100*	69.8	21,800*	72.2	17,500*	25
30	56.3	16,800	62.0	17,000	66.0	17,100	69.0	15,000*	30
35	50.4	12,800	57.4	12,900	62.2	13,100	65.7	13,100*	35
40	43.9	10,000	52.5	10,200	58.1	10,300	62.2	10,400	40
45	36.5	7,900	47.2	8,100	53.9	8,300	58.7	8,300	45
50	27.3	6,300	41.4	6,600	49.5	6,700	55.1	6,800	50
55	13.0	5,000	34.8	5,300	44.7	5,500	51.2	5,600	55
60	**		26.9	4,300	39.5	4,500	47.2	4,600	60
65			15.5	3,400	33.6	3,600	42.8	3,700	65
70			**		26.6	2,900	38.0	3,000	70
75					17.0	2,300	32.7	2,400	75
80					**		26.4	1,900	80
85							18.1	1,400	85
90							**		90

** MAXIMUM CAPACITY AT 0 DEGREE BOOM ANGLE

BOOM LENGTH 30 FT		BOOM LENGTH 39 FT		BOOM LENGTH 50 FT		BOOM LENGTH 61 FT		BOOM LENGTH 72 FT		BOOM LENGTH 83 FT		BOOM LENGTH 94 FT	
LOAD RADIUS (FT)	360° (LB)	LOAD RADIUS (FT)	360° (LB)	LOAD RADIUS (FT)	360° (LB)	LOAD RADIUS (FT)	360° (LB)	LOAD RADIUS (FT)	360° (LB)	LOAD RADIUS (FT)	360° (LB)	LOAD RADIUS (FT)	360° (LB)
25.6	20,100	34.3	12,100	45.3	7,300	56.3	4,700	67.3	3,000	78.3	1,900	89.3	1,000

Lifting Capacities – Pounds (30' – 94' boom)

MODEL RT 335

COUNTERWEIGHT:
W/AUX. WINCH 8900 LBS.
W/O AUX. WINCH 10,000 LBS.
BOOM LENGTH 30-94 FT.
OUTRIGGER SPREAD 22 FT.

STABILITY PERCENTAGE
ON OUTRIGGERS 85%
ON TIRES 75%
PCSA CLASS 10-156

CAUTION: Do not use this specification sheet as a load rating chart. The format of data is not consistent with the machine chart and may be subject to change.

ON OUTRIGGERS – RETRACTED

LOAD RADIUS (FT)	BOOM LENGTH 30 FT		BOOM LENGTH 39 FT		BOOM LENGTH 50 FT		LOAD RADIUS (FT)
	LOADED BOOM ANGLE (DEG)	360° (LB)	LOADED BOOM ANGLE (DEG)	360° (LB)	LOADED BOOM ANGLE (DEG)	360° (LB)	
10	63.0	51,000	69.4	46,600*			10
12	58.5	35,800	66.2	36,500	71.7	37,100	12
15	51.4	23,800	61.2	24,500	68.0	25,000	15
20	37.4	14,000	52.3	14,800	61.6	15,300	20
25	13.7	8,800	42.0	9,800	54.8	10,400	25
30	**		28.8	6,700	47.3	7,300	30
35			**		38.7	5,200	35
40					27.9	3,700	40
45					7.9	2,400	45
50					**		50
55							55
60							60

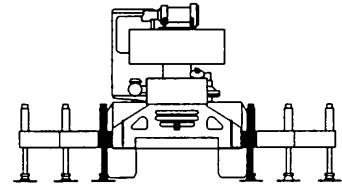

**USE THESE CHARTS
WHEN ALL OUTRIGGER
BEAMS ARE NOT IN
EITHER THE MID OR
FULLY EXTENDED
POSITION**

LOAD RADIUS (FT)	BOOM LENGTH 61 FT		BOOM LENGTH 72 FT		BOOM LENGTH 83 FT		BOOM LENGTH 94 FT		LOAD RADIUS (FT)
	LOADED BOOM ANGLE (DEG)	360° (LB)	LOADED BOOM ANGLE (DEG)	360° (LB)	LOADED BOOM ANGLE (DEG)	360° (LB)	LOADED BOOM ANGLE (DEG)	360° (LB)	
10									10
12									12
15	72.1	25,300							15
20	67.1	15,600	70.8	15,800					20
25	61.9	10,600	66.5	10,800	69.8	10,900	72.2	11,000	25
30	56.3	7,600	62.0	7,800	66.0	7,900	69.0	8,000	30
35	50.4	5,500	57.4	5,700	62.2	5,800	65.7	5,900	35
40	43.9	4,000	52.5	4,200	58.1	4,400	62.2	4,500	40
45	36.5	2,900	47.2	3,100	53.9	3,300	58.7	3,400	45
50	27.3	2,000	41.4	2,200	49.5	2,400	55.1	2,500	50
55	13.0	1,200	34.8	1,500	44.7	1,700	51.2	1,800	55
60	**		26.9	900	39.5	1,100	47.2	1,200	60

** MAXIMUM CAPACITY AT 0 DEGREE BOOM ANGLE

BOOM LENGTH 30 FT		BOOM LENGTH 39 FT		BOOM LENGTH 50 FT		BOOM LENGTH 61 FT		BOOM LENGTH 72 FT		BOOM LENGTH 83 FT		BOOM LENGTH 94 FT	
LOAD RADIUS (FT)	360° (LB)	LOAD RADIUS (FT)	360° (LB)	LOAD RADIUS (FT)	360° (LB)	LOAD RADIUS (FT)	360° (LB)	LOAD RADIUS (FT)	360° (LB)	LOAD RADIUS (FT)	360° (LB)	LOAD RADIUS (FT)	360° (LB)
25.6	8,200	34.3	4,700	45.3	2,300	56.3	1,000						

Lifting Capacities – Pounds (30' – 94' boom)

MODEL RT 335

COUNTERWEIGHT:
W/AUX. WINCH 8900 LBS.
W/O AUX. WINCH 10,000 LBS.
BOOM LENGTH 30-94 FT.
OUTRIGGER SPREAD 22 FT.

STABILITY PERCENTAGE
ON OUTRIGGERS 85%
ON TIRES 75%
PCSA CLASS 10-156

CAUTION: Do not use this specification sheet as a load rating chart. The format of data is not consistent with the machine chart and may be subject to change.

ON TIRES

RADIUS (FT)	MAX BOOM LENGTH (FT)	23.5R25				21:00 X 25-28PR				RADIUS (FT)
		STATIONARY		PICK & CARRY		STATIONARY		PICK & CARRY		
		360°	STRAIGHT OVER FRONT	CREEP	2.5 MPH	360°	STRAIGHT OVER FRONT	CREEP	2.5 MPH	
10	30	30,900	63,700*	46,700*	39,000*	30,500	73,700*	56,000*	47,400*	10
12	30	24,900	55,500	40,600*	33,800*	25,400	64,500*	48,900*	41,200*	12
15	39	19,100	43,100	33,600*	27,800*	18,900	46,800	40,700*	34,100*	15
20	39	12,400	24,600	24,600	20,900*	11,600	24,900	24,900	24,900	20
25	50	8,400	16,400	16,400	16,100	7,600	16,500	16,500	16,500	25
30	50	5,600	12,500	12,500	12,500	5,200	12,600	12,600	12,600	30
35	50	4,300	9,600	9,600	9,600	3,900	9,600	9,600	9,600	35
40	61	3,000	7,500	7,500	7,500	2,800	7,600	7,600	7,600	40
45	61	2,300	6,100	6,100	6,100	2,100	6,200	6,200	6,200	45
50	61	1,600	5,000	5,000	5,000	1,400	5,200	5,200	5,200	50
55	61		4,300	4,300	4,300		4,300	4,300	4,300	55
60	72		3,500	3,500	3,500		3,600	3,600	3,600	60
65	72		2,800	2,800	2,800		2,800	2,800	2,800	65
70	83		2,200	2,200	2,200		2,200	2,200	2,200	70
75	83		1,800	1,800	1,800		1,900	1,900	1,900	75
80	94		1,500	1,500	1,500		1,500	1,500	1,500	80

NOTES FOR ON TIRE CAPACITIES

- A. For Pick and Carry operations, boom must be centered over the front of the crane with swing brake and lock engaged. Use minimum boom point height and keep load close to ground surface.
- B. The load should be restrained from swinging. NO ON TIRE OPERATION WITH JIB ERECTED.
- C. Without outriggers, never maneuver the boom beyond listed load radii for applicable tires to ensure stability.
- D. Creep speed is crane movement of less than 200 Ft. (61m) in a 30 minute period and not exceeding 1.0 mph (1.6 km/h).
- E. Refer to General Notes for additional information.

SIDE STOW JIB ON FULLY EXTENDED OUTRIGGERS

LOADED BOOM ANGLE (DEG)	32 FT OFFSETTABLE JIB						49 FT OFFSETTABLE JIB						LOADED BOOM ANGLE (DEG)
	0° OFFSET		15° OFFSET		30° OFFSET		0° OFFSET		15° OFFSET		30° OFFSET		
	LOAD RADIUS (REF) (FT)	360° (LB)	LOAD RADIUS (REF) (FT)	360° (LB)	LOAD RADIUS (REF) (FT)	360° (LB)	LOAD RADIUS (REF) (FT)	360° (LB)	LOAD RADIUS (REF) (FT)	360° (LB)	LOAD RADIUS (REF) (FT)	360° (LB)	
75	38	9,100*	46	7,700*	52	5,900*	41	5,100*	55	3,400*	62	2,700*	75
73	42	8,600*	49	7,300*	55	5,800*	47	4,800*	59	3,300*	68	2,700*	73
71	45	8,200*	52	7,000*	58	5,600*	52	4,500*	64	3,200*	73	2,600*	71
68	50	7,800*	58	6,200*	63	5,100*	60	4,100*	70	3,000*	79	2,500*	68
65	56	6,700*	63	5,500*	68	4,600*	66	3,800*	76	2,900*	84	2,500*	65
62	61	5,900*	68	4,900*	73	4,200*	71	3,600*	81	2,800*	88	2,400*	62
59	66	5,200*	73	4,400*	77	3,800*	77	3,400*	86	2,700*	93	2,400*	59
55	73	4,400*	79	3,900*	83	3,400*	84	3,100*	93	2,600*	99	2,300*	55
51	79	3,800*	85	3,400*	88	3,100*	91	2,900*	99	2,500*	105	2,300*	51
47	86	3,300*	91	3,000*	94	2,800*	100	2,800*	106	2,400*	110	2,200*	47
43	92	2,900*	97	2,700*	99	2,500*	109	2,400*	112	2,200*	116	2,000*	43
38	100	2,400*	103	2,300*	105	2,200*	116	2,100*	119	1,900*	122	1,800*	38
32	106	2,100*	109	2,000*	110	1,900*	122	1,800*	126	1,600*	127	1,500*	32
25	113	1,700*	114	1,700*			129	1,500*	131	1,400*			25
17	118	1,500*	118	1,500*			133	1,300*	135	1,200*			17
0	121	1200*					138	1,000*					0

NOTES FOR JIB CAPACITIES

- A. For all boom lengths less than the maximum with a jib erected, the rated loads are determined by boom angle only in the appropriate column.
- B. For boom angle not shown, use the capacity of the next lower boom angle.
- C. Listed radii are for extended main boom only.

MAX. PERMISSIBLE HOIST LOAD

LINE PARTS	1	2	3	4	5	6	7	8
MAX. LOAD	9,080	18,160	27,240	36,320	45,400	54,480	65,560	72,640
BOOM HEAD	2	3-D	2-3	1-4-D	2-3-4	2-3-4-D	1-2-3-4	1-2-3-4-D
HOOK BLOCK	D	3	3-D	1-4	2-3-D	2-3-4	2-3-4-D	1-2-3-4
WIRE ROPE: 5/8" ROTATION RESISTANT COMPACTED STRAND, 18X19 OR 19X19 MINIMUM BREAKING STRENGTH - 22.7 TONS								
5/8" 6X19 OR 6X37 IWPC IPS PREFORMED RIGHT REGULAR LAY MINIMUM BREAKING STRENGTH - 17.9 TONS								

RECOMMENDED TIRE PRESSURE

TIRE SIZE	STATIONARY	CREEP	2 1/2 MPH	TRAVEL
23.5R25-**	94 PSI	94 PSI	94 PSI	76 PSI
21.00 X 25-28 PR	85 PSI	85 PSI	85 PSI	65 PSI

GENERAL NOTES

GENERAL

1. Rated loads as shown on Lift Charts pertain to this machine as originally manufactured and equipped. Modifications to the machine or use of optional equipment other than that specified can result in a reduction of capacity.
2. Construction equipment can be hazardous if improperly operated or maintained. Operation and maintenance of this machine shall be in compliance with the information in the Operator's, Parts and Safety Manuals supplied with this machine. If these manuals are missing, order replacements from the manufacturer through your distributor.
3. These warnings do not constitute all of the operating conditions for the crane. The operator and job site supervision must read the OPERATORS MANUAL, CIMA SAFETY MANUAL, APPLICABLE OSHA REGULATIONS, AND SOCIETY OF MECHANICAL ENGINEERS (ASME) SAFETY STANDARDS FOR CRANES.
4. This crane and its load ratings are in accordance with POWER CRANE & SHOVEL ASSOCIATION, STANDARD NO. 4, SAE CRANE LOAD STABILITY TEST CODE J765A, SAE METHOD OF TEST FOR CRANE STRUCTURE, J1063 AND APPLICABLE SAFETY CODE FOR CRANES, DERRICKS AND HOISTS, ASME/ANSI B30.5.

DEFINITIONS

1. **LOAD RADIUS** – The horizontal distance from the axis of rotation before loading to the center of the vertical hoist line or tackle with a load applied.
2. **LOADED BOOM ANGLE** – It is the angle between the boom base section and the horizontal, after lifting the rated load at the rated radius. The boom angle before loading should be greater to account for deflections. The loaded boom angle combined with boom length give only an approximation of the operating radius.
3. **WORKING AREA** – Areas measured in a circular arc about the centerline of rotation as shown in the diagram.
4. **FREELY SUSPENDED LOAD** – Load hanging free with no direct external force applied except by the hoist rope.
5. **SIDE LOAD** – Horizontal force applied to the lifted load either on the ground or in the air.
6. **NO LOAD STABILITY LIMIT** – The stability limit radius shown on the range diagrams is the radius beyond which it is not permitted to position the boom, when the boom angle is less than the minimum shown on the applicable load chart, because the machine can overturn without any load.
7. **BOOM SIDE OF CRANE** – The side of the crane over which the boom is positioned when in an OVER SIDE working position.

SET-UP

1. Crane load ratings are based on the crane being leveled and standing on a firm, uniform supporting surface.
2. Crane load ratings on outriggers are based on all outrigger beams being fully extended or in the case of partial extension ratings mechanically pinned in the appropriate position, and the tires free of the supporting surface.
3. Crane load ratings on tires depend on appropriate inflation pressure and the tire conditions. Caution must be exercised when increasing air pressures in tires. Consult Operator's Manual for precautions.
4. Use of jibs, lattice-type boom extensions, or fourth section pullouts extended is not permitted for pick and carry operations.
5. Consult appropriate section of the Operator's and Service Manual for more exact description of hoist line reeving.
6. The use of more parts of line than required by the load may result in having insufficient rope to allow the hook block to reach the ground.
7. Properly maintained wire rope is essential for safe crane operation. Consult Operator's Manual for proper maintenance and inspection requirements.
8. When spin-resistant wire rope is used, the allowable rope loading shall be the breaking strength divided by five (5), unless otherwise specified by the wire rope manufacturer.
9. Do not elevate the boom above 60° unless the boom is positioned in-line with the crane's chassis or the outriggers are extended. Failure to observe this warning may result in loss of stability.

WE RESERVE THE RIGHT TO AMEND THESE SPECIFICATIONS AT ANY TIME WITHOUT NOTICE. THE ONLY WARRANTY APPLICABLE IS OUR STANDARD WRITTEN WARRANTY APPLICABLE TO THE PARTICULAR PRODUCT AND SALE. WE MAKE NO OTHER WARRANTY, EXPRESSED OR IMPLIED.

OPERATION

1. **CRANE LOAD RATINGS MUST NOT BE EXCEEDED. DO NOT ATTEMPT TO TIP THE CRANE TO DETERMINE ALLOWABLE LOADS.**
2. When either radius or boom length, or both, are between listed values, the smaller of the two listed load ratings shall be used.
3. Do not operate at longer radii than those listed on the applicable load rating chart (cross hatched areas shown on range diagrams).
4. The boom angles shown on the Capacity Chart give an approximation of the operating radius for a specified boom length. The boom angle, before loading, should be greater to account for boom deflection. It may be necessary to retract the boom if maximum boom angle is insufficient to maintain rated radius.
5. Power telescoping boom sections must be extended equally.
6. Rated loads include the weight of hook block, slings, and auxiliary lifting devices. Their weights shall be subtracted from the listed rated load to obtain the net load that can be lifted.
When lifting over the jib the weight of any hook block, slings, and auxiliary lifting devices at the boom head must be added to the load.
When jibs are erected but unused add two (2) times the weight of any hook block, slings, and auxiliary lifting devices at the jib head to the load.
7. Rated loads do not exceed 85% on outriggers or 75% on tires, of the tipping load as determined by SAE Crane Stability Test Code J765a. Structural strength ratings in chart are indicated with an asterisk (*).
8. Rated loads are based on freely suspended loads. No attempt shall be made to drag a load horizontally on the ground in any direction.
9. The user shall operate at reduced ratings to allow for adverse job conditions, such as: Soft or uneven ground, out of level conditions, high winds, side loads, pendulum action, jerking or sudden stopping of loads, hazardous conditions, experience of personnel, two machine lifts, traveling with loads, electric wires, etc., (side pull on boom or jib is hazardous). Derating of the cranes lifting capacity is required when wind speed exceeds 20 MPH. The center of the lifted load must never be allowed to move more than 3" feet off the center line of the base boom section due to the effects of wind, inertia, or any combination of the two.
*Use 2 feet off the center line of the base boom for a two section boom, 3 feet for a three section boom, or 4 feet for a four section boom.
10. The maximum load which can be telescoped is not definable, because of variations in loadings and crane maintenance, but it is permissible to attempt retraction and extension if load ratings are not exceeded.
11. Load ratings are dependent upon the crane being maintained according to manufacturer's specifications.
12. It is recommended that load handling devices, including hooks, and hook blocks, be kept away from boom head at all times.
13. **FOR TRUCK CRANES ONLY:** 360° capacities apply only to machines equipped with a front outrigger jack and all five (5) outrigger jacks properly set. If the front (5th) outrigger jack is not properly set, the work area is restricted to the over side and over rear areas as shown on the Crane Working Positions diagram. Use the 360° load ratings in the overside work areas.
14. Do not lift with outrigger beams positioned between the fully extended and intermediate (pinned) positions.
15. Truck Cranes not equipped with equalizing (bogie) beams between the rear axles may not be used for lifting "on tires". Truck Cranes equipped with equalizing beams and rear air suspension should "dump" the air before lifting "on tires".

CLAMSHELL, MAGNET, AND CONCRETE BUCKET SERVICE

1. Maximum boom length for clamshell and magnet service is 50 feet.
2. Weight of clamshell or magnet, plus contents are not to exceed 6,000 pounds or 90% of rated lifting capacities, whichever is less. For concrete bucket operation, weight of bucket and load must not exceed 90% of rated lifting capacity.



TEREX

Waverly Operations
106 12th Street S.E.
Waverly, IA 50677-9466 USA
TEL: (319) 352-3920
FAX: (319) 352-5727
E-MAIL: inquire@terexwaverly.com
WEB: <http://www.terex-cranes.com>